

Operating Instructions

Control Head

AQUA-SK-IO-Link



AquaDuna

FLUID PROCESS GROUP

www.aquaduna.com

Imprint

Original operating instructions

As of November 2018
Revision 03

AquaDuna GmbH & Co.KG
Ferdinand-von-Steinbeis-Ring 31
D-75447 Sternenfels
Tel.: 07045 / 204980
Fax.: 07045 / 204990
www.aquaduna.com

Table of contents

Imprint.....	2
Table of contents.....	3
1. General.....	5
1.1 Information about the operating instructions.....	5
1.2 Symbols.....	5
1.3 Limitation of liability.....	6
1.4 Copyright protection.....	6
1.5 Warranty provisions.....	6
2 Safety.....	7
2.1 Intended use.....	7
2.2 Responsibility of the operator.....	7
2.3 Qualification of personnel.....	8
2.4 Protective equipment.....	8
3 Technical specifications.....	9
3.1 IO-Link electronics.....	9
3.2 Requirements for the control air according to DIN ISO 8573-1:2001.....	9
4 Structure and function.....	10
4.1 Brief description.....	10
4.2 Overview.....	10
4.3 Control head variants.....	11
4.4 Position determination.....	12
4.5 Accessories, tools.....	12
4.6 Scope of delivery.....	12
5 Connections.....	13
5.1 Pneumatic connection.....	13
5.2 Electrical connections.....	13
5.2.1 Connection of power supply cable.....	13
5.2.2 Connector P1 connector, 3-pin.....	14
5.2.3 Connector 10 pin.....	14
5.2.4 Connector M12- 4-pin assignment.....	14
5.2.4 LED signaling.....	15
5.2.5 Solenoid valve plug connections.....	15

6 Setting of magnetic encoder globe valves	16
6.1 Double seat leakage valves	16
6.2 Angle valves	16
6.3 Changeover valve.....	17
6.4 Aseptic valves.....	17
7 IO-Link data	18
7.1 IO-Link process data	18
7.2 IO-Link parameters	19
7.2.1 Parameter table	19
7.2.2 Parameter meaning.....	20
7.2.2.1 Parameter valve type	20
7.3 IO-Link commands.....	22
7.4 IO-Link diagnostic messages	22
8 Transport	23
8.1 Safety.....	23
8.2 Transport inspection	23
8.3 Packaging.....	23
8.4 Transport.....	23
8.5 Storage.....	24
9 Initial start-up	25
9.1 Safety.....	25
9.2 Connection.....	25
9.2.1 Variant with cable gland	25
9.2.2 Variant with plug connection.....	25
10 Operation, use.....	26
10.1 Integration in a higher-level system.....	26
11 Maintenance.....	27
11.1 Dismantling, replacement of the control head.....	27
11.1.1 Dismantling the control head.....	27
11.2 Spare and wear parts	28
12 Faults.....	28
13 Disassembly, Disposal.....	29
13.1 Disposal	29
14 Declaration of incorporation	30

1. General

1.1 Information about the operating instructions

These instruction enables safe handling of the product. The user must read and understand the instructions carefully before starting any work. The basic requirement for safe working is adherence to all specified safety instructions.

The instructions are part of the product and must be kept freely accessible at all times for each person handling the product.

In addition to these instructions, the local accident-prevention regulations and the national health and safety conditions apply.

1.2 Symbols

Safety instructions

	Caution, danger!
	Type and source of danger! Possible consequences in case of disregard of the danger and → Measures to avert the danger.

	Warning, highest danger!
	Type and source of danger! Possible consequences in case of disregard of the danger and → Measures to avert the danger.

Tips

	Important NOTICE!
	Description of a notice.

1.3 Limitation of liability

The statutory liability conditions apply. Liability is excluded for the following:

- Failure to follow these instructions
- Non-intended use
- Use of untrained personnel
- Use of unauthorised spare parts
- Unauthorised modifications made by the operator, which are not agreed with the manufacturer and approved
- The general terms and conditions also apply.

1.4 Copyright protection

These operating instructions are copyright protected.

© Copyright by AquaDuna GmbH & Co. KG (2018)

The transfer of these operating instructions to third parties, duplication in any kind and form – even in part – as well as the utilisation and/or communication of the contents are not permitted without written consent.

In individual cases, it is permissible to pass on the operating instructions to third parties or to duplicate them for internal use by the operator or for training purposes.

1.5 Warranty provisions

The statutory warranty period of one year applies. Applicable warranty conditions can also be found in the sales documents.

2 Safety

2.1 Intended use

IO-Link control heads are suitable for use on Kieselmann drives for globe and rotary valves and ball valve drives as well as for use on all drives with a suitable encoder system.

The following is prohibited in particular:

- Supply of unsuitable media in the compressed air connection.
- Improper connection of the electronics.
- Operation of the control head without cover.

The control head IO-Link is not approved for operation in the ATEX area!

	Warning, highest danger!
	Danger due to incorrect operation and use in non-approved areas! → Training of employees (→ see 2.3)

2.2 Responsibility of the operator

The operator is the person who operates the product for commercial or business purposes or provides it to a third party for use/application and bears legal product responsibility during operation for the protection of the user, personnel and third parties.

It is the duty of the operator:

- To know and implement the applicable health and safety regulations.
- To identify hazards that result from the working conditions at the site in a risk assessment.
- To create operating instructions for the operation of the product.
- To check regularly whether the operating instructions correspond to the current state of the regulations.
- To clearly define and specify the responsibilities for installation, operation, troubleshooting, maintenance and cleaning.
- To ensure that all employees have read and understood the operating instructions.
- To train personnel at regular intervals and to inform them about the dangers; the operating and maintenance personnel must be presented with these operating instructions for information.

2.3 Qualification of personnel

In order to force an emergency shutdown of the control head, the operators of the system must be absolutely familiar with the system concept. It is essential that an emergency shutdown is trained and the necessary elements for an emergency shutdown are made known. The training and instruction of the persons who have been entrusted with the system operation must be documented. All personal injury and damage to property resulting from faulty operation or faulty use are borne by the system operator.

	<p>Trained and instructed personnel Trained and instructed personnel are persons who, through their education or training and instruction, are qualified for their area of responsibility and can carry out any work they do independently.</p>
---	--

2.4 Protective equipment

Protective equipment is not necessary when handling the control head IO-Link.

3 Technical specifications

3.1 IO-Link electronics

Supply voltage	24V DC
Supply voltage range	±10%
Current consumption max.	80mA (24V DC)
Ambient temperature	5°C to 60°C
Protection class	IP 67 DIN EN 60529
With stainless steel hood	DIN EN 61140 I

3.2 Requirements for the control air according to DIN ISO 8573-1:2001

Particle size max.	5 µm
Particle density max.	5mg/m ³ class 3
Water content	dew point 2°C class 3
Oil content	Oil free max. 25mg/m ³ class 3
Air pressure	6 - 8 bar
Air volume	160 l/min at 6bar

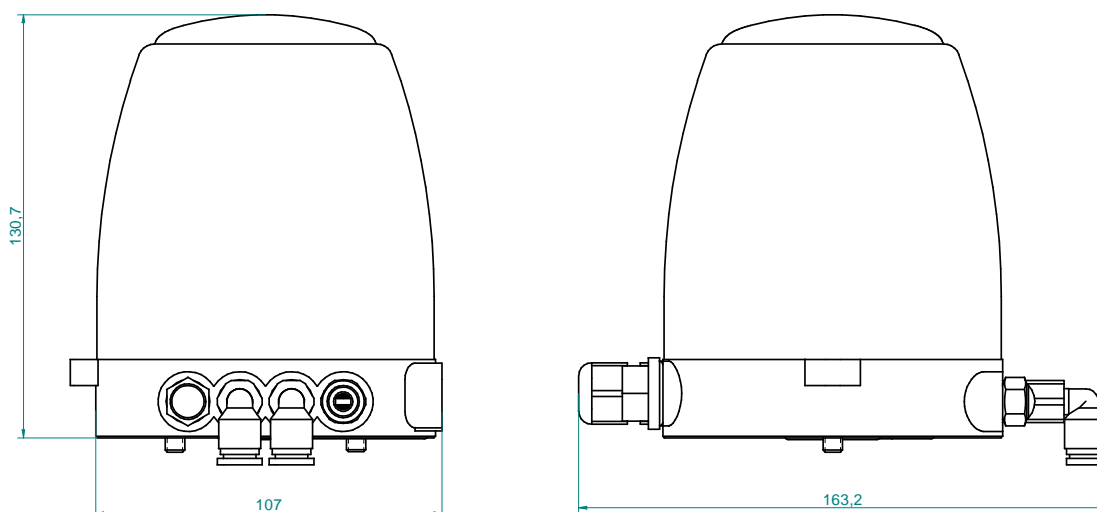

4 Structure and function

4.1 Brief description

The control head IO-Link uses the pilot valves to control the movements of the valves described at the beginning (→ see 4.3)

4.2 Overview

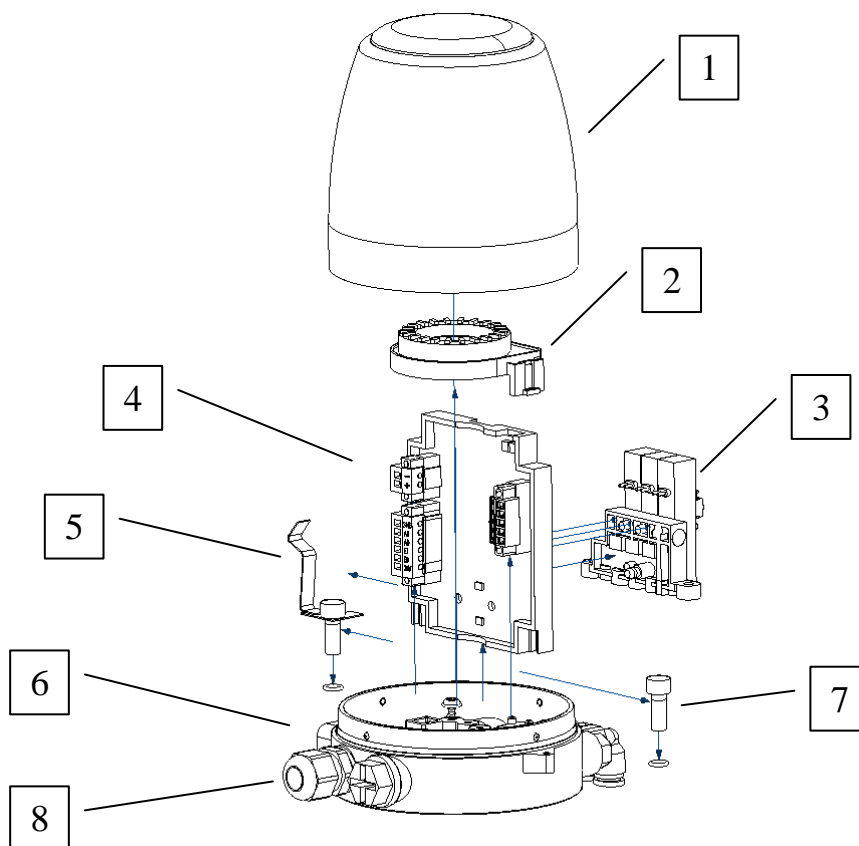

- | | |
|---------------------|--|
| 1 - Hood | 5 - Grounding spring (only with stainless steecover) |
| 2 - Top LED display | 6 - Lower part |
| 3 - Pilot valves | 7 - Attachment screws |
| 4 - Electronics | 8 - Cable gland or 4-pin plug |

4.3 Control head variants



Plastic hood



Stainless steel hood



Cable gland



4-pin plug

4.4 Position determination

The position of the lift drive is determined by a magnetic carrier. This carrier is located in the spindle of the valve.

For rotary drives, a rotary encoder with magnets is used to determine the position.



Magnetic carrier for
globe valves

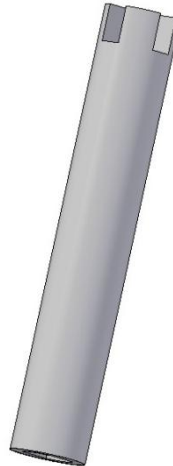

Rotary encoder for
rotary valves

4.5 Accessories, tools

1. Torx screwdriver size T20
2. Allen key size 5
3. Screwdriver long blade size 3
4. Screwdriver size 2

4.6 Scope of delivery

The scope of delivery of the control head includes:

- 1 x control head
- 1 x operating instructions

5 Connections

5.1 Pneumatic connection



P - Pneumatic connection
6 bar, → see 3. Technical data!
Pneumatic hose Ø 6 mm,
calibrated outside.

AR1/2 connections valve

5.2 Electrical connections

5.2.1 Connection of power supply cable

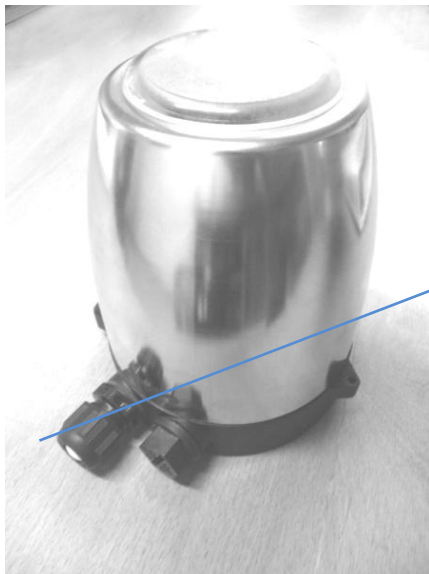

Cable gland

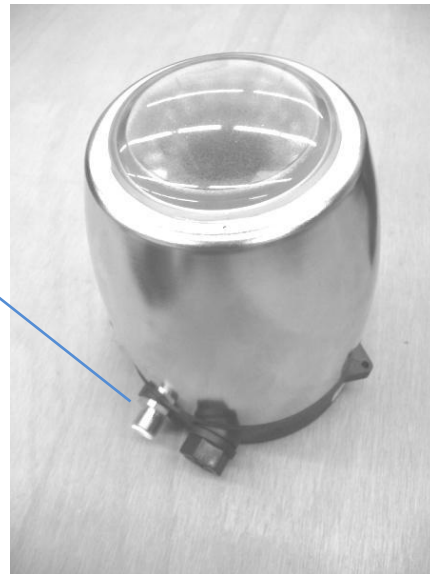

M12 4-pin plug

5.2.2 Connector P1 connector, 3-pin

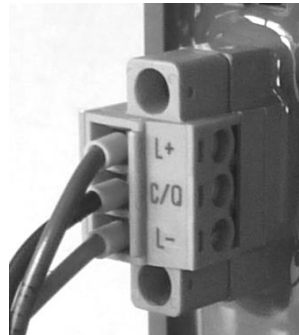
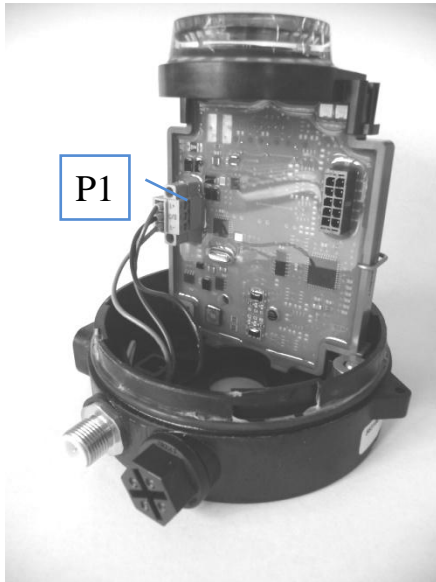

- Plug P 1. 1 L + (brown)
- Plug P 1. 2 C/O (black)
- Plug P 1. 3 L- (blue)

5.2.3 Connector 10 pin

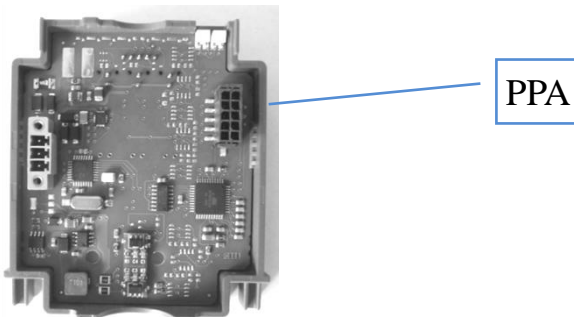

Programming connection, do not use for operation.

5.2.4 Connector M12- 4-pin assignment

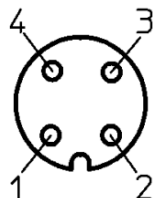

- | | | |
|---|-----|---------|
| 1 | L+ | - brown |
| 2 | - | - |
| 3 | L- | - blue |
| 4 | C/O | - black |

5.2.4 LED signaling

Signaling of the retractor position by the LED of the top LED display or the circuit board.

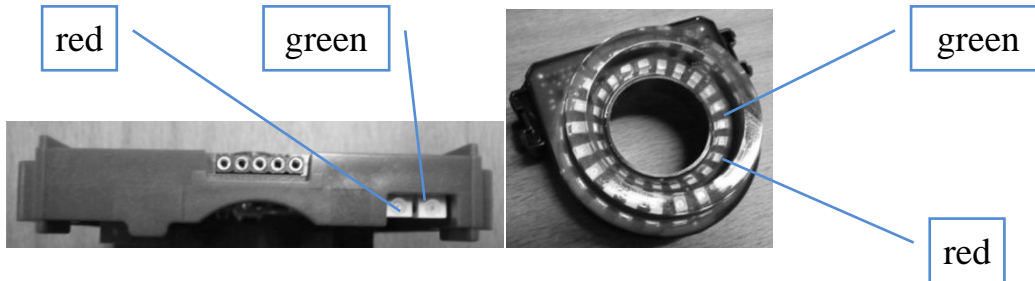

Basic position → red

Working position → green

Undefined intermediate position → red-green flashing

5.2.5 Solenoid valve plug connections

Plug P 5. 1 MV 3 -
Plug P 5. 2 MV 3 +

Plug P 7. 1 MV 2 -
Plug P 7. 2 MV 2 +

Plug P 10. 1 MV 1 -
Plug P 10. 2 MV 1 -

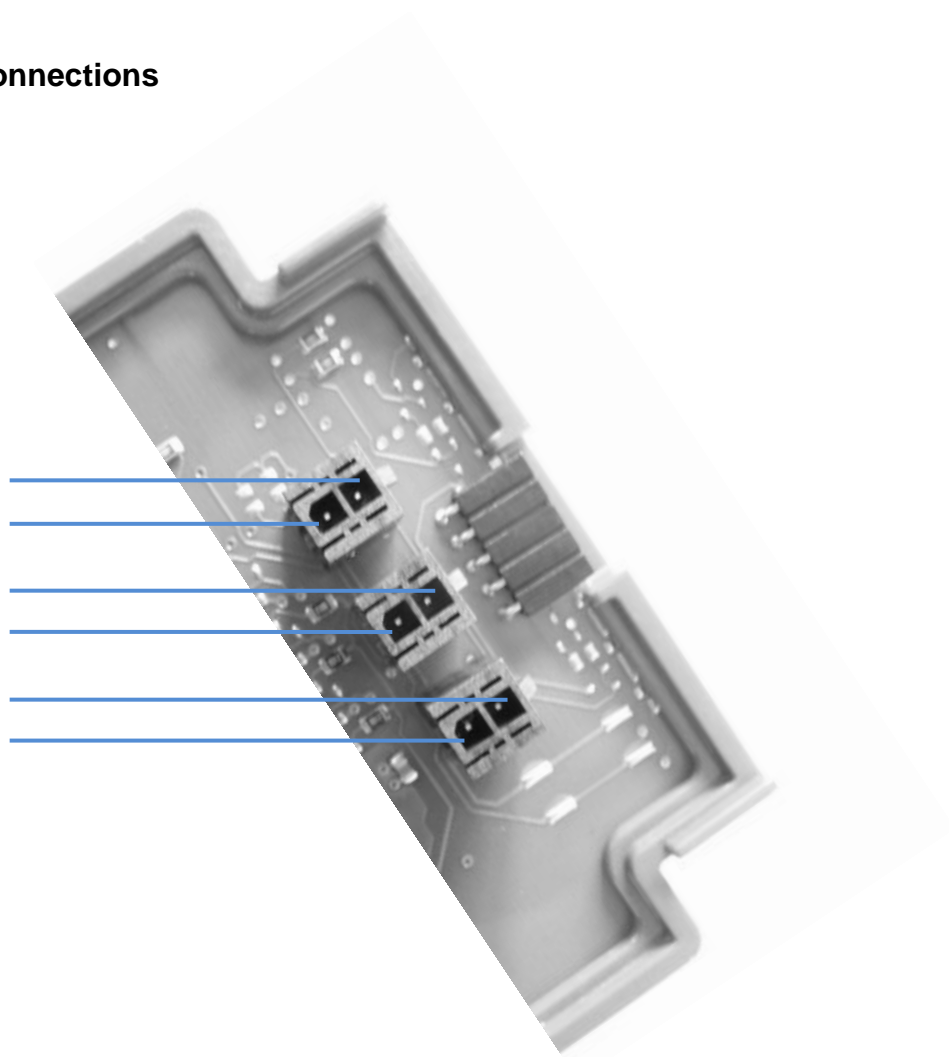

6 Setting of magnetic encoder globe valves

6.1 Double seat leakage valves

(E.g.: 5670...) $A = 46.5 + 0.5$
 $B = 51.0^{-0.5} + \text{Lift}_{\text{measurable}}$ or
 $B = 51.0^{-0.5} + (\text{Lift}_{\text{theoretical}} - \text{Leakage space})$

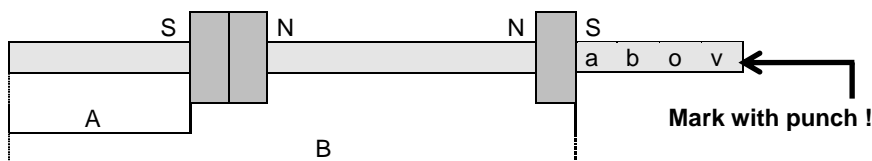

Nominal width	Lift	Leakage-R	(Lift cycle)	A ^{+0.5}	B ^{-0.5}	Springs	Position indicator
DN 25	21.8	2.5	5.0	46.5	70.5	1	5620.025.005-K000
DN 40	28.0	2.5	5.0	46.5	76.5	1	5620.040.005-K000
DN 50	34.0	2.5	5.0	46.5	82.5	2	5620.050.005-K000
DN 65	43.0	2.5	5.0	46.5	91.5	2	5620.065.005-K000
DN 80	51.5	3.5	6.0	46.5	99.0	2	5620.080.005-K000
DN 100	61.5	3.5	6.0	46.5	109.0	3	5620.100.005-K000
DN 125 /150	65.0	3.5	6.0	56.5	122.5	3	5620.150.005-K000

6.2 Angle valves

(E.g.: 5536...) $A = 43.5 + 0.5$
 $B = 51.0 - 0.5 + \text{Lift}_{\text{measurable}}$ or
 $B = 51.0 - 0.5 + (\text{Lift}_{\text{theoretical}})$

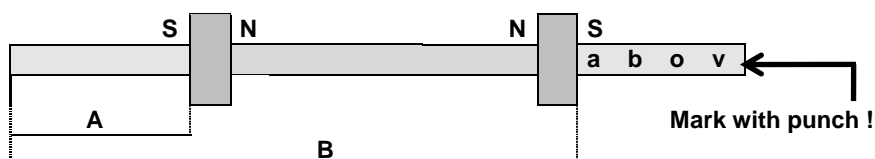

Nominal width	Lift	A	B	Springs	Position indicator
DN 25	22.0	43.5	73.0	2	5702.025.005-K000
DN 40 /32	24.0	43.5	75.0	2	5702.040.005-K000
DN 50	26.0	43.5	77.0	2	5702.065.005-K000
DN 65	26.0	43.5	77.0	2	5702.065.005-K000
DN 80	35.0	43.5	86.0	2	5702.100.005-K000
DN 100	35.0	43.5	86.0	2	5702.100.005-K000

6.3 Changeover valve

(E.g.: 5714...)

Nominal width	Lift	A	B	Springs	Position indicator
DN 25 /32	18.5	43.5	69.5	1	5714.025.005-K000
DN 40	24.0	43.5	75.0	2	5702.040.005-K000
DN 50	26.0	43.5	77.0	2	5702.065.005-K000
DN 65	26.0	43.5	77.0	2	5702.065.005-K000
DN 80	35.0	43.5	86.0	2	5702.100.005-K000
DN 100	35.0	43.5	86.0	2	5702.100.005-K000

6.4 Aseptic valves

(E.g.: 5836...)

Nominal width	Lift	A	B	Springs	Position indicator
DN 25	10.0	43.5	61.0	1	5802.025.005-K000
DN 40	12.0	43.5	63.0	1	5802.040.005-K000
DN 50	17.0	43.5	68.0	1	5802.050.005-K000
DN 65	21.0	43.5	72.0	1	5802.065.005-K000
DN 80	24.0	43.5	75.0	2	5702.040.005-K000
DN 100	29.0	43.5	80.0	2	5802.100.005-K000
DN 125	34.0	43.5	85.0	2	5802.125.005-K000
DN 150	40.0	43.5	91.0	2	5802.150.005-K000

7 IO-Link data

7.1 IO-Link process data

Input data from the master	
Byte 1	
Bit (low nibble)	Function
1	Close
2	Open
4	Lower seatlift
8	Upper seatlift
Hi Nibble	Must stay 0
Byte 2	
Bit 0	Identification signaling
Byte 3,4 not used, further use	

Output data to the master	
Byte 1	
Bit (low nibble)	Function
0	Unknown position / moving
1	Closed
2	Open
4	Lower seatlift
8	Upper seatlift
Hi Nibble	0
Byte 2	
Bit 0	Remote rec. Plugged
1	Remote locked
2	Teaching
3 - 7	Not used
Byte 3,4 not used, further use	

7.2 IO-Link parameters

7.2.1 Parameter table

Index (dec)	Index (hex)	Type	Size	Parameter	Access	Values range	Default	Hardware
64	0x40	Uint8	8 Bit	Vtype	rw	0..31	0	
73	0x49	Uint8	8 Bit	LED Mode	rw	0..4	4	
75	0x4B	Uint8	8 Bit	Op Mode	rw		0	
76	0x4C	Uint8	5* 8 Bit	FP_Closed	rw		0	Premium
77	0x4D	Uint8	5* 8 Bit	FP_Open	rw		0	Premium
78	0x4E	Uint8	5* 8 Bit	FP_LowerSeatlift	rw		0	Premium
79	0x4F	Uint8	5* 8 Bit	FP_UpperSeatlift	rw		0	Premium
80	0x50	Uint16	16 Bit	Angle Closed	rw	0..1023	0	Further use
81	0x51	Uint16	16 Bit	Angle Open	rw	0..1023	0	Further use
82	0x52	Uint8	8 Bit	PosTolerance Close	rw		0	Premium
83	0x53	Uint8	8 Bit	PosTolerance Open	rw		0	Premium
84	0x54	Uint8	8 Bit	PosToleranceLowerSeatlift	rw		0	Premium
85	0x55	Uint8	8 Bit	PosToleranceUpperSeatlift	rw		0	Premium
65	0x41	Uint16	16 Bit	C_PwrOn	ro		0	
66	0x42	Uint16	16 Bit	C_Close	ro		0	
67	0x43	Uint16	16 Bit	C_Open	ro		0	
68	0x44	Uint16	16 Bit	C_LowerSeatlift	ro		0	
69	0x45	Uint16	16 Bit	C_UpperSeatlift	ro		0	
70	0x46	Int8	8 Bit signed	Temperature minimal	ro		+100	
71	0x47	Int8	8 Bit signed	Temperature maximal	ro		-100	
72	0x48	Int8	8 Bit signed	Temperature actual	ro		-	

7.2.2 Parameter meaning

7.2.2.1 Parameter valve type

Vtyp (decimal)	Description IO-Link LIGHT and PREMIUM
0	Double seat valve, normal position open, with cycle, without cycle detection.
1	Double seat valve, normal position closed, without cycle.
2	Double-seat valve, normal position closed, with cycle only above, without cycle detection.
4	Single-seat valve, normal position closed, spring-closing.
5	Single-seat valve, normal position closed, air-opening / air-closing.
6	Single-seat valve, normal position open, spring-opening.
7	Double-seat valve, normal position closed, with cycle, without cycle detection.
8	Butterfly valve, normal position closed, spring-closing.
9	Butterfly valve, normal position closed, air-opening / air-closing.
10	Butterfly valve, normal position open, spring-opening.
12	Single-seat valve, normal position open, air-opening / air-closing.
13	Butterfly valve, normal position closed, air-opening / air-closing.

Additionally only with PREMIUM version

Vtyp (decimal)	Description
3	Double-seat valve, normal position closed, with cycle, without cycle detection, with teach IN.
11	Single seat valve, normal position closed, spring closing, with teach IN.
14	Single seat valve. Normal position open, spring opening, with teach IN.

The valve positions of types 3, 11 and 14 must be learned → see 7.3

7.2.2.2 Other parameters

Parameter	Function
Brightness TopLed	Brightness settings Top Led; 0-off; 4-maximum brightness
Operation Mode	Operation mode; Bit0 signaling of undefined position suppressed
Fingerprint closed	Stored position pattern "closed" (globe valves)
Fingerprint open	Stored position pattern "open" (globe valves)
Fingerprint lower seatlift	Stored position pattern "cycle bottom" (lift valves)
Fingerprint upper seatlift	Stored position pattern "cycle top" (globe valves)
Angle Closed	Stored angular position "closed" (rotary valves)
Angle Open	Stored angular position "open" (rotary valves)
Tolerance closed	Maximum tolerated deviation from learned position "position closed"
Tolerance open	Maximum tolerated deviation from learned position "position open"
Tolerance lower seat lift	Maximum tolerated deviation from learned position "cycle bottom"
Tolerance upper seatlift	Maximum tolerated deviation from the learned position "cycle top"
Counter power on	Switch-on counter
Counter close	Counter "position closed"
Counter open	Counter "position open"
Counter lower seat lift	Counter "cycle bottom"
Counter upper seatlift	Counter "cycle top"
Temperature minimal	Lowest operating temperature
Temperature maximal	Highest operating temperature
Temperature actual	Current operating temperature

7.3 IO-Link commands

IO-Link commands			
Value (dec.)	Value (hex.)	Command	Function
160	A0	Counter reset	Reset all counters
161	A1	Temperature reset	Reset min-max temperature values
162	A2	Start teaching	Learn the valve positions

7.4 IO-Link diagnostic messages

IO-Link events					
Value (dec.)	Value (hex.)	Meaning	Occurrence	Type	Cause
6200	1838	Configuration error	Appear/Disappear	Error	Hardware used for settings inappropriate
6201	1839	Impossible position	Single shot	Warning	Control for valve type unsuitable
6202	183A	No fingerprint data	Appear/Disappear	Error	No or damaged position patterns
6203	183B	Teach error	Appear/Disappear	Error	Learning failed

8 Transport

8.1 Safety

	Caution, danger!
	Danger of injury due to weight! When the package falls, body parts can be injured. → Do not throw the package → Wear safety shoes → Place the package on a firm horizontal surface

8.2 Transport inspection

Upon receipt of the product, a transport inspection must be carried out. The packaging must be examined for external damage. Extensive damage to the packaging must be noted immediately on the transport documents together with the transport company.

The content is to be examined for completeness. If damage to the packaging is already visible, the contents must be examined for further transport damage. In case of incompleteness or damage in transit, the manufacturer must be consulted immediately.

8.3 Packaging

	Hazard to the environment through incorrect disposal!
	Packaging materials are valuable raw materials and in many cases can continue to be used, processed and reused. Incorrect disposal of packaging materials can be hazardous to the environment. → Dispose of packaging materials in an environmentally friendly manner → Observe locally applicable disposal regulations.

8.4 Transport

The product should be removed from the packaging.

For further transport, ensure sufficient packaging. The packaging must be able to absorb shocks and impacts. The packaging itself must not cause any damage to the product and must prevent external damage to the product, such as scratches, from occurring. The product must not move freely in the packaging.

8.5 Storage

To avoid damage to the product due to incorrect storage, the following storage conditions must be observed:

- Avoid mechanical shocks.
- Observe operating temperatures even during storage.
- Use only permissible media.
- Check for damage at the end of storage.
- Check functioning at the end of storage.

9 Initial start-up

9.1 Safety

	Caution, danger!
	Danger due to its own weight! If the product falls, it may be damaged. Use flat, horizontal non-slip surface for storage.

9.2 Connection

	Warning, highest danger!
	Danger due to improper connection! → Note point 5, connections. → Observe requirements for the control air, point 3.

Connection to the higher-level control and the pneumatic supply (P) is done by the operator. The following procedure must be followed:

9.2.1 Variant with cable gland

- Open the hood by turning the hood about 15° counterclockwise.
- Connect the connection cable to the 3-pin connector P1 according to 5.2.2.
- Close the hood while checking the tightness of the hood.
- Connect the compressed air supply according to 5.1.

9.2.2 Variant with plug connection

- Connect the 4-pole plug connection according to 5.2.1.
- Connect the compressed air supply according to 5.1.

10 Operation, use

10.1 Integration in a higher-level system

If the control head is integrated in an automatically operating system, it must be ensured that the control head can be monitored in terms of its functionality. Monitoring must be ensured by the system concept. A visual check must also be carried out at certain intervals. The functional check must be documented via optical inspection. If faults or damage are found during the inspection, these must be remedied immediately.

When operating in automatic systems, the operators must become familiar with the shutdown process or the emergency shutdown of the system.

	Warning, highest danger!
	Danger due to incorrect operation! → Training of employees (→ see 2.3)

11 Maintenance



11.1 Dismantling, replacement of the control head

11.1.1 Dismantling the control head

Be sure to observe safety instructions in 2.

Note the figure on page 20!

- Disconnect the control head from the power and compressed air supply.
- Open the hood by turning the hood about 15° counterclockwise.
- Open the attachment screws. Attention: grounding spring will also loosen at the same time with the stainless steel hood!
- Lift the control head.
- Screw on the new control head with the attachment screws. Make sure that the O-rings in the lower part are correctly positioned and that the grounding spring is correctly fastened!
- Close the hood while checking the tightness of the hood.
- Connect the compressed air supply according to 5.1.

	Warning, highest danger!
	Danger due to improper connection! → Note point 5, connections. → Observe requirements for the control air, point 3.
	Warning, highest danger!
	Danger due to improper installation! → Check the seat of the grounding spring, as the equipotential bonding is no longer guaranteed if the mounting is incorrect. (Be4i variant with stainless steel hood)

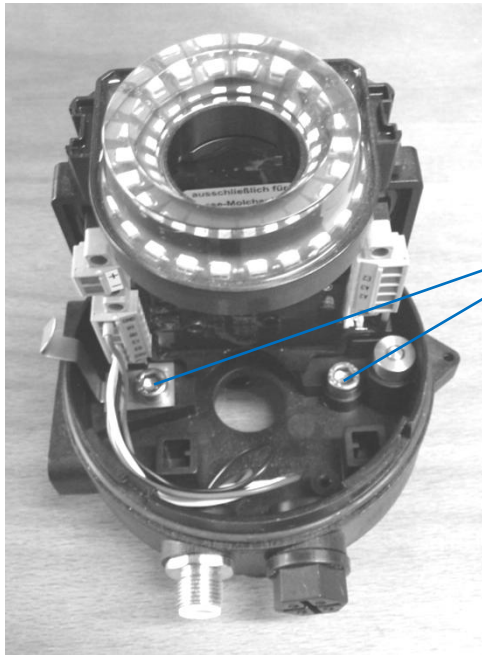

Attachment screws

11.2 Spare and wear parts

Plastic Hood Spare Part Art. No. 301503
Stainless Steel Hood Display Spare part Art. No. 301499
O Ring Set Spare Part Art. No. 303035
SOLENOID VALVE-1PDA Spare Part Art. No. 201421
IO-Link Control Board Spare Part Art. No. 307453
Top LED Display Spare Part Art. No. 920118

12 Faults

In the event of faults, inform:

AquaDuna GmbH & Co. KG, Ferdinand-von-Steinbeis-Ring 31
D-75447 Sternenfels, Tel.: 07045 / 204980, Fax.: 07045 / 204990
www.aquaduna.com

13 Disassembly, Disposal

The disassembly of the control head is carried out as described in section 11 Maintenance.

13.1 Disposal

The various components of the control head require separate disposal sorted by material. The materials can be found in the respective parts lists.

	Hazard to the environment through incorrect disposal!
	<p>Materials are valuable raw materials and in many cases can continue to be used, processed and reused. Incorrect disposal of materials can be hazardous to the environment.</p> <ul style="list-style-type: none"> → Dispose of materials in an environmentally friendly manner → Observe locally applicable disposal regulations.



14 Declaration of incorporation