



**KIESELMANN**  
FLUID PROCESS GROUP

## Operating instructions

- Translation of the original -

### Bunging valve

#### Type: 6267

with and without safety function  
spring loaded  
for gas



# 1. List of contents

1.	List of contents .....	1
2.	General safety instructions .....	2
2.1	Information for your safety .....	2
2.2	Marking of security instructions in the operating manual .....	2
2.3	Designated use .....	2
2.4	Personnel .....	2
2.5	Modifications, spare parts, accessories .....	2
2.6	General instructions .....	2
3.	Safety instructions .....	3
3.1	Field of application .....	3
3.2	General safety instructions .....	3
3.3	General notes .....	3
4.	Function .....	3
4.1	General functional description .....	3
4.2	Manual operation .....	3
5.	Installation informations .....	4
5.1	Installation instructions .....	4
5.2	Welding guidelines .....	4
5.3	Pressure setting .....	4
6.	Maintenance .....	4
6.1	Maintenance .....	4
6.2	Cleaning .....	4
7.	Technical Data .....	5
8.	Disassembly and assembly .....	6
8.1	Remove the seals (D1), (D2), (D3) .....	6
8.2	Assembly .....	6
9.	Drawing .....	7
10.	Dimensions .....	8
11.	Spare parts list .....	8
12.	Blow-off performance chart .....	9
13.	Declaration of incorporation .....	17

## 2. General safety instructions

### 2.1 Information for your safety

We are pleased that you have decided for a high-class KIESELMANN product. With correct application and adequate maintenance, our products provide long time and reliable operation.



Before installation and initiation, please carefully read this instruction manual and the security advices contained in it. This guarantees reliable and safe operation of this product and your plant respectively. Please note that an incorrect application of the process components may lead to great material damages and personal injury.

**In case of damages caused by non observance of this instruction manual, incorrect initiation, handling or external interference, guarantee and warranty will lapse!**

Our products are produced, mounted and tested with high diligence. However, if there is still a reason for complaint, we will naturally try to give you entire satisfaction within the scope of our warranty. We will be at your disposal also after expiration of the warranty. In addition, you will also find all necessary instructions and spare part data for maintenance in this instruction manual. If you don't want to carry out the maintenance by yourself, our KIESELMANN service team will naturally be at your disposal.

### 2.2 Marking of security instructions in the operating manual

Hints are available in the chapter "safety instructions" or directly before the respective operation instruction. The hints are highlighted with a danger symbol and a signal word. Texts beside these symbols have to be read and adhered to by all means. Please continue with the text and with the handling at the valve only afterwards.

Symbol	Signal word	Meaning
	<b>DANGER</b>	Imminent danger which may cause severe personal injury or death.
	<b>ATTENTION</b>	Dangerous situation which may cause slight personal injury or material damages.
	<b>NOTE</b>	Marks application hints and other information which is particularly useful.

### 2.3 Designated use

The fitting is designed exclusively for the purposes described below. Using the fitting for purposes other than those mentioned is considered contrary to its designated use. KIESELMANN cannot be held liable for any damage resulting from such use. The risk of such misuse lies entirely with the user. The prerequisite for the reliable and safe operation of the fitting is proper transportation and storage as well as competent installation and assembly.

Operating the fitting within the limits of its designated use also involves observing the operating, inspection and maintenance instructions.

### 2.4 Personnel

Personnel entrusted with the operation and maintenance of the tank safety system must have the suitable qualification to carry out their tasks. They must be informed about possible dangers and must understand and observe the safety instructions given in the relevant manual. Only allow qualified personnel to make electrical connections.

### 2.5 Modifications, spare parts, accessories

Unauthorized modifications, additions or conversions which affect the safety of the fitting are not permitted. Safety devices must not be bypassed, removed or made inactive. Only use original spare parts and accessories recommended by the manufacturer.

### 2.6 General instructions

The user is obliged to operate the fitting only when it is in good working order. In addition to the instructions given in the operating manual, please observe the following:

- relevant accident prevention regulations
- generally accepted safety regulations
- regulations effective in the country of installation
- working and safety instructions effective in the user's plant.

### 3. Safety instructions

#### 3.1 Field of application

The bunging valve is primarily intended to be used to hold the pressure of gaseous media in tanks and containers consistently and to prevent overpressures if the safety function is set.



#### ATTENTION

- To avoid danger and damage, the fitting must be used in accordance with the safety instructions and technical data contained in the operating instructions.

#### 3.2 General safety instructions



#### DANGER

- Dismantling the valve or valve assemblies from the plant can cause injuries from fluids or gases flowing out.  
Dismantle the valve or valve assembly only when the plant has been rendered pressure-less and free of liquid and gas.
- Referring to the used sealing materials the valves are suitable for a minimum operating temperature at -5 °C. An operation at low process or ambient temperatures may affect the safety function.  
Therefore, appropriate measures shall be taken for an operation at temperatures below +5 °C.



#### ATTENTION

- Internal or external dirt may impair the function of the fitting or the safety equipment. Therefore the fitting must be operated in a way that protects it from external influences and it must be cleaned and maintained at regular intervals.
- Steps should be taken to ensure that no external forces are exerted on the fitting.

#### 3.3 General notes



#### NOTE

- All data are in line with the current state of development. Subject of change as a result of technical progress.

### 4. Function

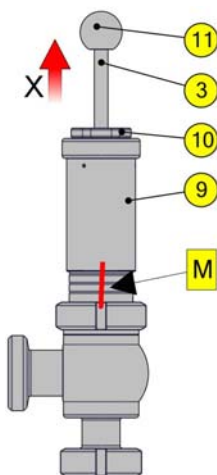

#### 4.1 General functional description

The valve opens against spring force if the set pressure is crossed. It closes if the current pressure drops under the set pressure (see "Blow-off performance chart" page 9).

Optional: For valves with safety function, a locking sleeve prevents, that the prescribed maximum pressure within the set range will be exceeded.

#### 4.2 Manual operation

The manual lifting lever serves to manually actuate the valve.

- Short term lifting of the valve takes place by pulling on the spindle (3) via the spherical button (11) and/or the lifting nut (10) in the direction X. This will raise the plate (2) and the medium disperses via outlet B.
- For a longer lifting of the valve (e.g. when cleaning), the lifting nut (10) is turned in a clockwise direction to the adjusting nut (9). Now mark the position with a pen/pencil. Unscrew the adjusting nut (9) anticlockwise using 2 complete turns. The plate (2) will be raised and the medium disperses via outlet B.
- In order to close the valve, the adjusting nut (9) is turned in an anticlockwise direction using 2 complete turns as far as the mark. Screw the lifting nut (10) anticlockwise as far as the spherical button (11) and tighten.

## 5. Installation informations

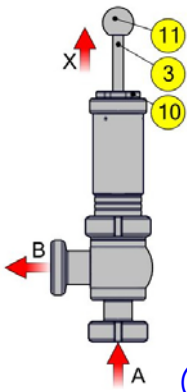

### 5.1 Installation instructions

#### Fitting position

As a general rule, the valve should be installed vertically on connection 'A'.

#### Performance test

After the installation, the working of the valve is checked through manual lifting. For this, pull the spherical button in the direction X.

### 5.2 Welding guidelines

Sealing elements integrated in weld components must generally be removed prior to welding. To prevent damage, welding should be undertaken by certified personnel (EN287). Use the TIG (tungsten inert gas) welding process.



#### NOTE

Impurities can cause damage to the seals. Clean inside areas prior to assembly.

### 5.3 Pressure setting

The set pressure can be adjusted to scaling in the pressure area by longitudinal positioning of the adjustment nut (9). The longitudinal positioning of the adjustment nut (9) occurs about a thread through rotary motion.

Optional: For valves with safety function, the adjustment nut is turned up to the locking sleeve, so that the prescribed maximum pressure within the set range will be not exceeded.



#### NOTE

The positioning of the lifting nut (10) is tightened in the operating mode using the spherical button (11). Were the lifting to come and rest upon the adjusting nut (9) the valve would not close tight enough to ensure a seal against the leakage of fluids.

## 6. Maintenance

### 6.1 Maintenance

The maintenance intervals depend on the operating conditions "temperature, temperature-intervals, medium, cleaning medium, pressure and opening frequency". We recommend replacing the seals every 1 years. The user, however should establish appropriate maintenance intervals according to the condition of the seals.



#### NOTE

EPDM; Viton; K-flex; NBR; HNBR  
Silicone  
Thread

⇒  
⇒  
⇒

#### Lubricant recommendation

Klüber Paraliq GTE703\*  
Klüber Sintheso pro AA2\*  
Interflon Food\*

\*) It is only permitted to use approved lubricants, if the respective fitting is used for the production of food or drink. Please observe the relevant safety data sheets of the manufacturers of lubricants.

### 6.2 Cleaning

Cleaning is best done when the valve is opened. For this, open the valve with the manual lifting lever. (see "Manual operation" page 3).

## 7. Technical Data

<b>Valve size:</b>	<ul style="list-style-type: none"> <li>• NPS 15 / 25 Bunging valve with and without safety function</li> <li>• NPS 25 / 32 Bunging valve with and without safety function</li> <li>• NPS 40 / 50 Bunging valve without safety function</li> </ul>			
<b>Connections:</b>	<ul style="list-style-type: none"> <li>• Liner / nut DIN11851</li> <li>• Male part DIN11851</li> </ul>			
<b>Temperature range:</b>	<ul style="list-style-type: none"> <li>• Ambient temperature: +4° to +45°C</li> <li>• Product temperature: +4° to +95°C medium-dependent</li> <li>• Sterilization temperature: EPDM +140°C (SIP 30 min)</li> </ul>			
<b>Leakage rate:</b>	A (DIN EN 12268-1)			
<b>Material:</b> <i>in product contact</i>	Stainless steel:	1.4404 / AISI316L 1.4301 / AISI304		
	Surfaces:	Ra < 0,8µm e-polished		
	Material of seals:	EPDM		
<b>Set range:</b>	Nominal pipe size	Operating range	Permissible opening / - Permissible closing differential	
	NPS 15	0,2 - 2,0 bar	± 0,1 bar (>2 bar ± 10 %)	
	-	0,5 - 3,0 bar	± 0,2 bar (>2 bar ± 10 %)	
	NPS 40	1,2 - 3,0 bar	± 0,2 bar (>2 bar ± 10 %)	
		1,5 - 4,0 bar	± 0,2 bar (>2 bar ± 10 %)	
<b>Safety function:</b>	Set pressure	discharge coefficient $\alpha_w$ NPS 15	discharge coefficient $\alpha_w$ NPS 25	discharge coefficient $\alpha_w$ NPS 40
	2,0 bar	0,36	0,18	-
	3,0 bar	0,35	0,23	-
	4,0 bar	0,35	0,26	-
<b>Identification:</b> <i>Valves with safety function</i>	<b>Identification (BS) &amp; manufacturer:</b> C € xxxx Logo			
	<b>Order number   year of manufacture:</b> Auftrags-Nr. / lfd. Nr. MM / JJ			
	<b>Characteristic value:</b>	$d_0 \cdot G \cdot \alpha_w \cdot xxx$		
	<b>Temperature range:</b>	TSmin: xx°C TSmax: xx°C		
	<b>Set pressure <math>P_e</math>   Fluid group:</b>	xx bar Fluid group x		
	<b>Item number:</b>	xxxxxxxx-xxx		

## 8. Disassembly and assembly

### 8.1 Remove the seals (D1), (D2), (D3)

- Screw the lifting nut (10) down to the adjustment nut (9) and screw for another 2-3 turns so that the valve plate is raised from the seal seat.
- Dismantle the slotted nut (6).
- Pull the valve insert from the housing (VG).
- Screw the lifting nut (10) back as far as the spherical button (11).
- In order to release the spherical button (11) the valve is clamped to the spindle (3) in the vice between soft jaws (see the figure on the right hand side).
- Unscrew the spherical button (11), unclamp the valve from the vice and unscrew the lifting nut (10).
- Carefully pull the complete spindle (3) from the spring housing (5).



#### NOTE

- When pulling the spindle (3) from the spring housing (5), make sure that the thread of the spindle does not damage the bearing (4) or the lip seal (D2).
- The piston (2) is joined to the spindle with a high-strength screw locking device and must not be disassembled.

- Re-clamp the spindle at position (F) (see Fig. 1 /page 7) in the vice between the soft jaws.
- Unscrew the piston plate (1) above the width flat SW1 and remove the O-ring (D1).
- Unscrew the adjustment nut (9) from the spring housing (5). The pressure spring will relax.
- Remove the O-ring (D3) and the lip seal (D2).

#### Remove the pressure spring (8)

- Unscrew the adjustment nut (9) from the spring housing (5). The pressure spring will relax.
- Remove the slotted nut (6), spring guide (12) (depending on the model), spring (8) and the spring plate (7).

### 8.2 Assembly

- Thoroughly clean and slightly lubricate mounting areas and running surfaces.
- Assemble in reverse order.



#### NOTE

##### Assembly O-Ring (D1)

- The installation spaces on the piston (2) and the piston plate (1) have to be carefully cleaned and slightly lubricated.
  - Clamp the spindle (3) between the soft jaws in the vice and clamp onto the surface (F).
  - Dampen the O-ring (D1) slightly with suitable grease and insert into the piston (2).
  - Screw in the piston plate (1) as far as the metallic arrester and make sure that the O-ring (D1) does not rotate with it or twist.
- Test the performance in the operating state according to the performance data.

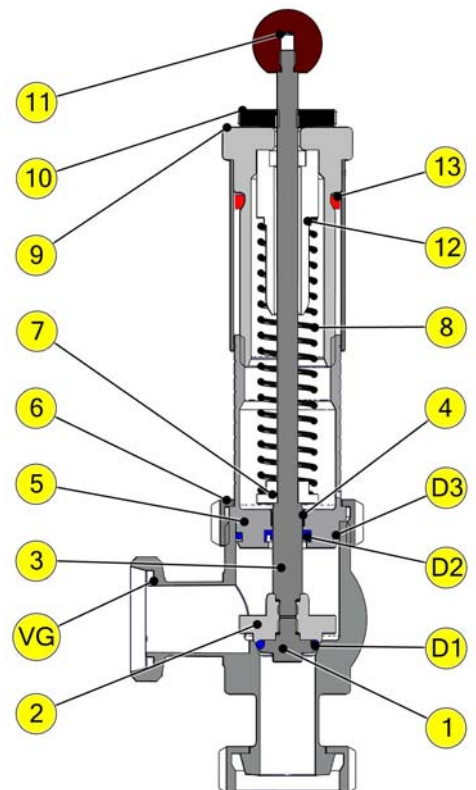

## 9. Drawing

- 1) Piston plate
  - 2) Piston
  - 3) Spindle
  - 4) Bush bearing
  - 5) Spring housing
  - 6) Nut
  - 7) Spring plate
  - 8) Pressure spring
  - 9) Adjustment nut
  - 10) Lifting nut
  - 11) Spherical button
  - 12) Spring guide
  - 13) Locking sleeve  
*(only for valves with safety function)*
- 
- D1) O-Ring
  - D2) Lip seal
  - D3) O-Ring
- 
- VG) Housing
  - G1) Lock nut - high strength
  - F) Clamping surface
  - SW) Spanner flat

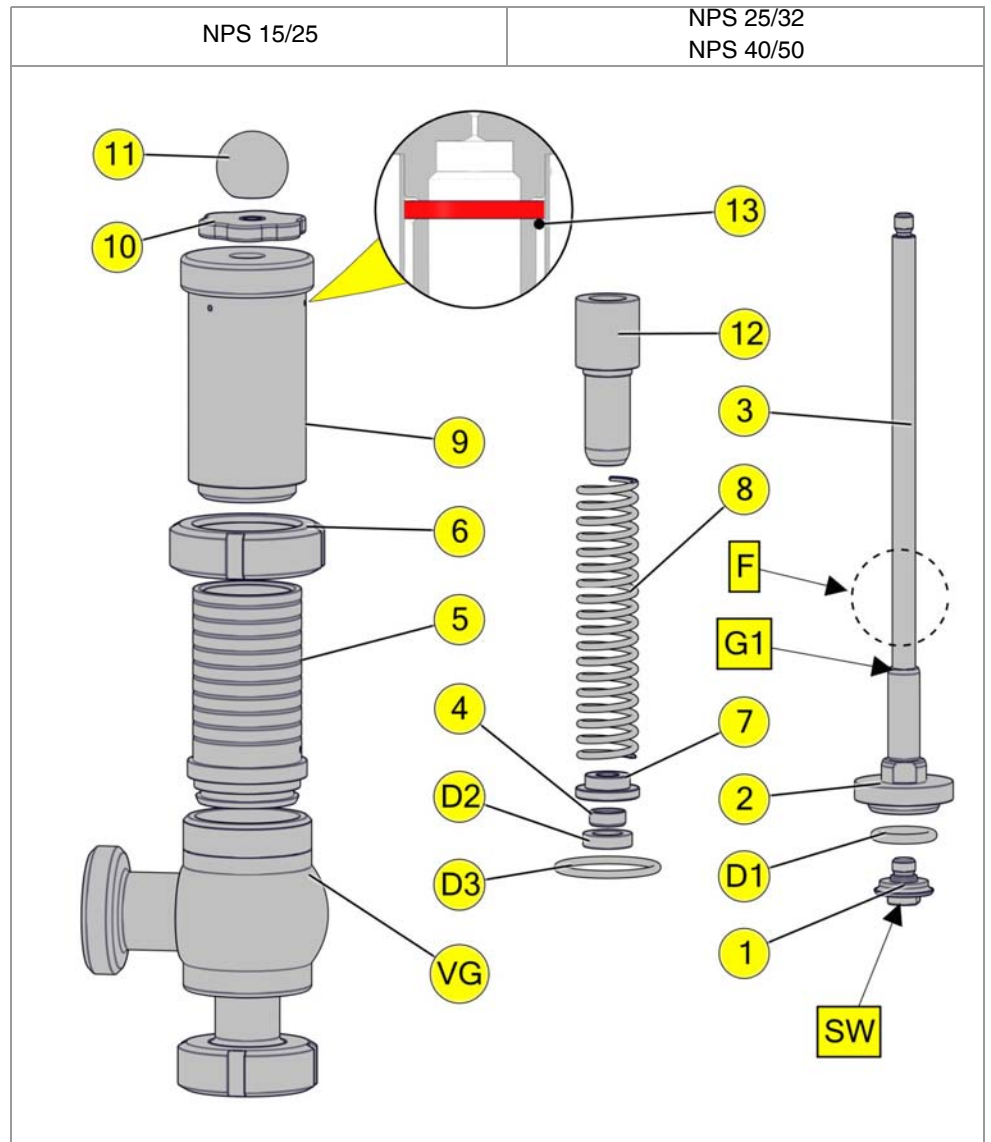

Fig. 1



## 10. Dimensions

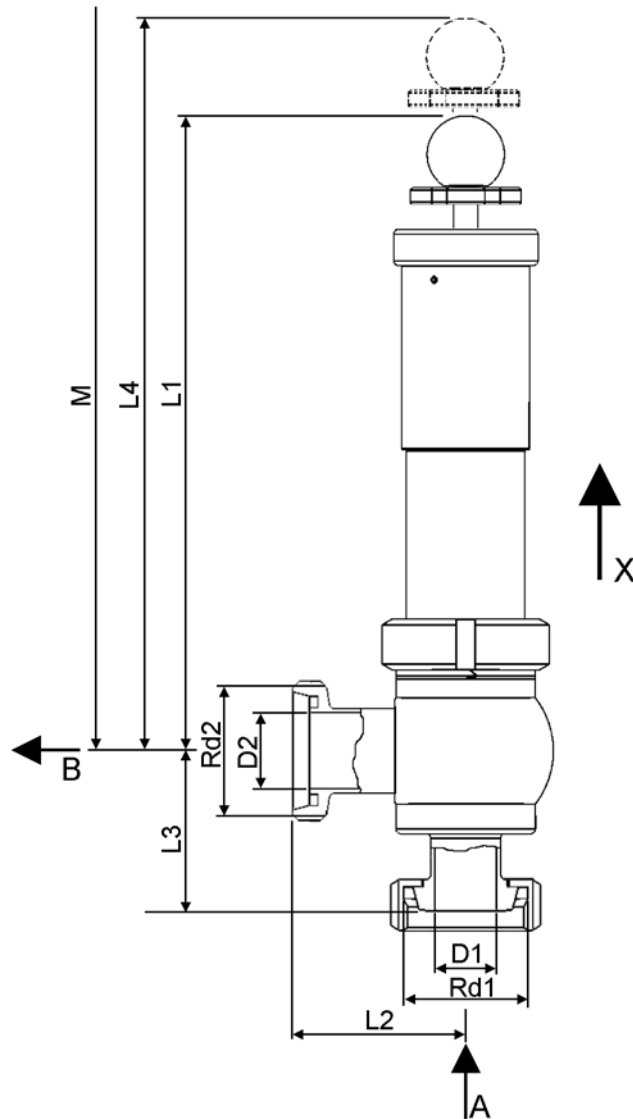

Fig. 2

NPS	D1	D2	Rd1	Rd2	L1	L2	L3	L4	M assembly dimension
15 / 25	16	26	Rd34x1/8	Rd52x1/8	280	77	61,5	12	340
25 / 32	26	32	Rd52x1/6	Rd58x1/6	282	72	72	21,5	350
40 / 50	38	50	Rd65x1/6	Rd78x1/6	279	74	91	24	360

## 11. Spare parts list

Item	Designation	Material	NPS		
			15 / 25	25 / 32	40 / 50
	Seal kit (D1-D3)	EPDM	6267 016 993-000	6267 026 993-000	6267 041 993-000
D1	O-Ring	EPDM	2304 012 030-170	2304 021 040-170	2304 032 040-069
D2	Lip seal	EPDM	2331 014 050-054	2331 014 050-054	2331 014 050-054
D3	O-Ring	EPDM	2304 041 035-159	2304 041 035-159	2304 041 035-159
4	Bearing bush	H370SM	8050 014 006-000	8050 014 006-000	8050 014 006-000

## 12. Blow-off performance chart

► Bunging valve DN15/25 | DN25/32 | DN40/50 Set pressure: 0,20-2,00 bar (air 20°C)

Set pressure (bar)	Reseating pressure (bar)			Volumetric flow rate (m³/h)								
				+ 0,1bar			+ 0,15bar			+ 0,2bar		
0,20 - 2,00	DN 15/25	DN 25/32	DN 40/50	DN 15/25	DN 25/32	DN 40/50	DN 15/25	DN 25/32	DN 40/50	DN 15/25	DN 25/32	DN 40/50
0.20	0,16	0,16	0,16	55,21	52,30	77,83	65,16	85,80	132,13	85,07	114,60	185,53
0.40	0,35	0,36	0,34	90,50	53,80	104,08	106,79	98,10	142,09	117,65	122,40	184,62
0.60	0,55	0,56	0,55	103,17	57,20	58,83	113,13	100,20	124,89	119,46	129,80	162,90
0.80	0,75	0,75	0,71	103,17	57,70	31,68	114,03	103,00	125,80	123,08	139,60	178,29
1.00	0,93	0,95	0,94	105,48	65,00	40,73	114,27	95,80	117,65	125,70	147,80	177,38
1.20	1,10	1,16	1,13	107,48	71,00	106,79	118,57	106,90	162,00	132,22	158,90	200,01
1.40	1,36	1,37	1,32	118,56	70,90	116,75	126,70	117,70	161,09	141,18	170,20	188,24
1.60	1,52	1,56	1,52	132,13	72,00	111,32	140,28	148,70	149,33	156,57	183,30	197,29
1.80	1,74	1,75	1,71	120,37	72,90	91,41	133,04	157,30	149,33	153,85	193,20	183,72
2.00	1,90	1,95	1,85	126,70	73,60	112,22	142,09	162,60	126,70	167,43	195,50	205,44

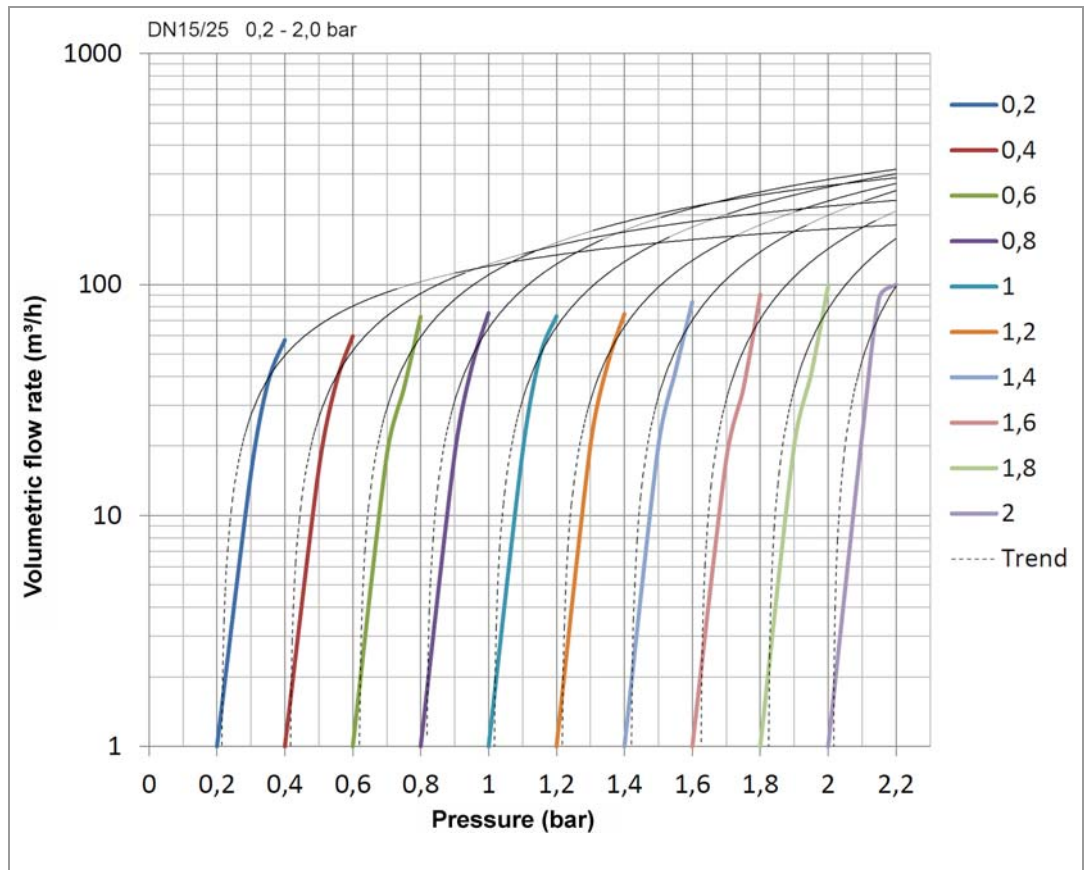

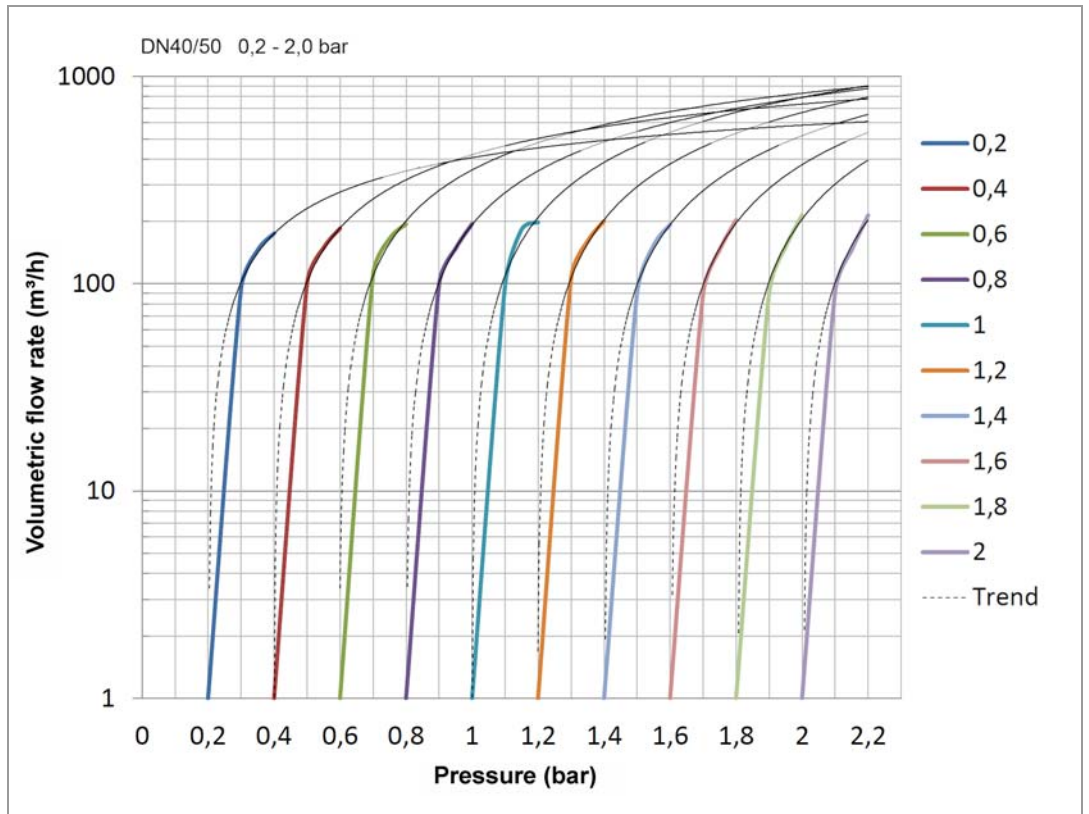
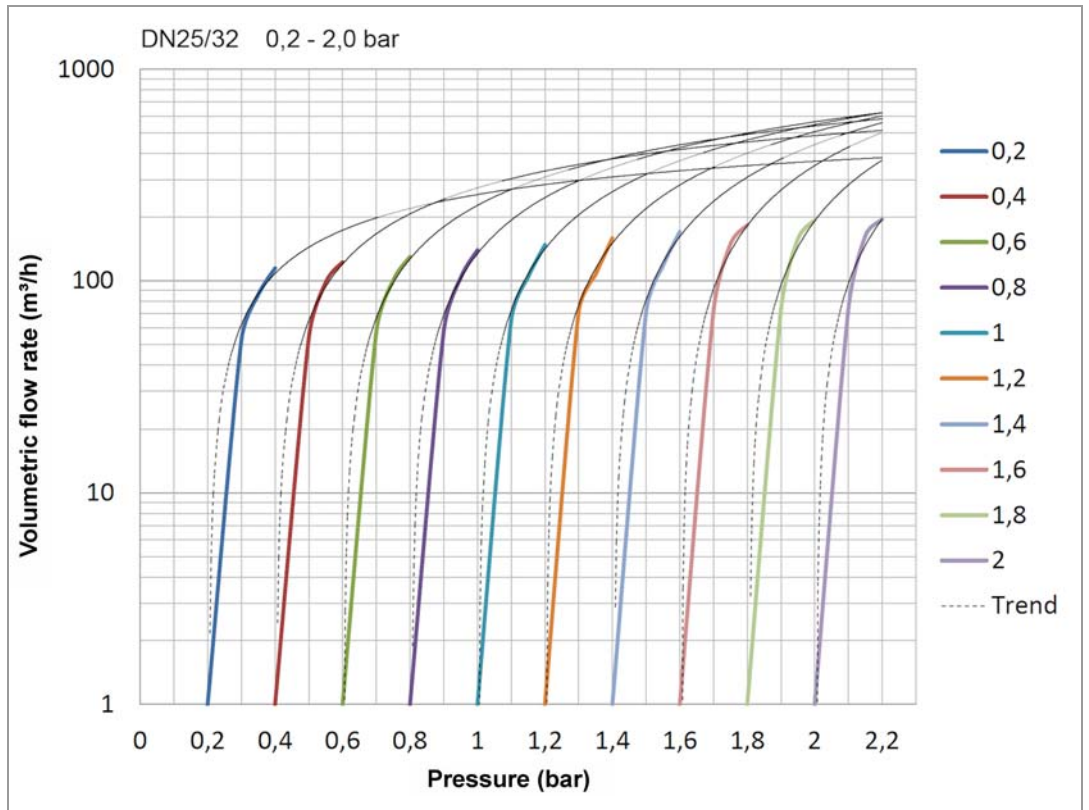

► Bunging valve DN15/25 | DN25/32 | DN40/50 Set pressure: 0,50 - 3,00 bar (air 20°C)

Set pressure (bar)	Reseating pressure (bar)			Volumetric flow rate (m³/h)											
				+ 0,1bar			+ 0,15bar			+ 0,2bar			+ 0,3bar		
0,50 - 3,00	DN 15/25	DN 25/32	DN 40/50	DN 15/25	DN 25/32	DN 40/50	DN 15/25	DN 25/32	DN 40/50	DN 15/25	DN 25/32	DN 40/50	DN 15/25	DN 25/32	DN 40/50
0,50	0,44	0,47	0,46	52,49	28,96	61,54	73,31	71,50	104,98	89,60	122,18	166,52	124,89	x	x
0,75	0,68	0,70	0,69	58,83	11,00	66,07	75,12	79,00	110,00	103,17	126,70	172,86	138,47	x	x
1,00	0,90	0,95	0,92	66,97	13,94	91,41	99,55	80,05	133,42	124,89	146,61	185,53	152,04	x	x
1,25	1,13	1,22	1,15	84,17	11,44	104,08	116,75	120,08	151,53	128,51	140,28	168,33	158,38	x	x
1,50	1,40	1,46	1,42	93,22	8,15	104,98	125,80	78,74	131,23	137,56	136,66	172,86	163,81	x	x
1,75	1,65	1,72	1,65	66,97	11,31	108,60	133,94	125,80	159,28	151,14	148,42	190,05	179,19	x	x
2,00	1,93	1,91	1,91	117,65	x	111,31	126,70	x	137,56	151,14	135,93	175,33	186,43	190,05	241,33
2,25	2,15	2,22	2,14	178,29	x	38,01	206,34	x	171,05	193,67	108,60	185,53	210,87	207,25	236,21
2,50	2,35	2,44	2,38	158,38	x	117,65	172,86	x	181,91	190,05	168,33	203,63	200,91	218,11	245,26
2,75	2,62	2,68	2,61	131,23	x	147,72	142,99	x	244,35	167,43	190,60	233,49	200,01	239,83	271,61
3,00	2,81	2,95	2,87	182,81	x	120,08	201,82	x	187,34	214,49	158,20	222,05	226,25	187,34	266,84

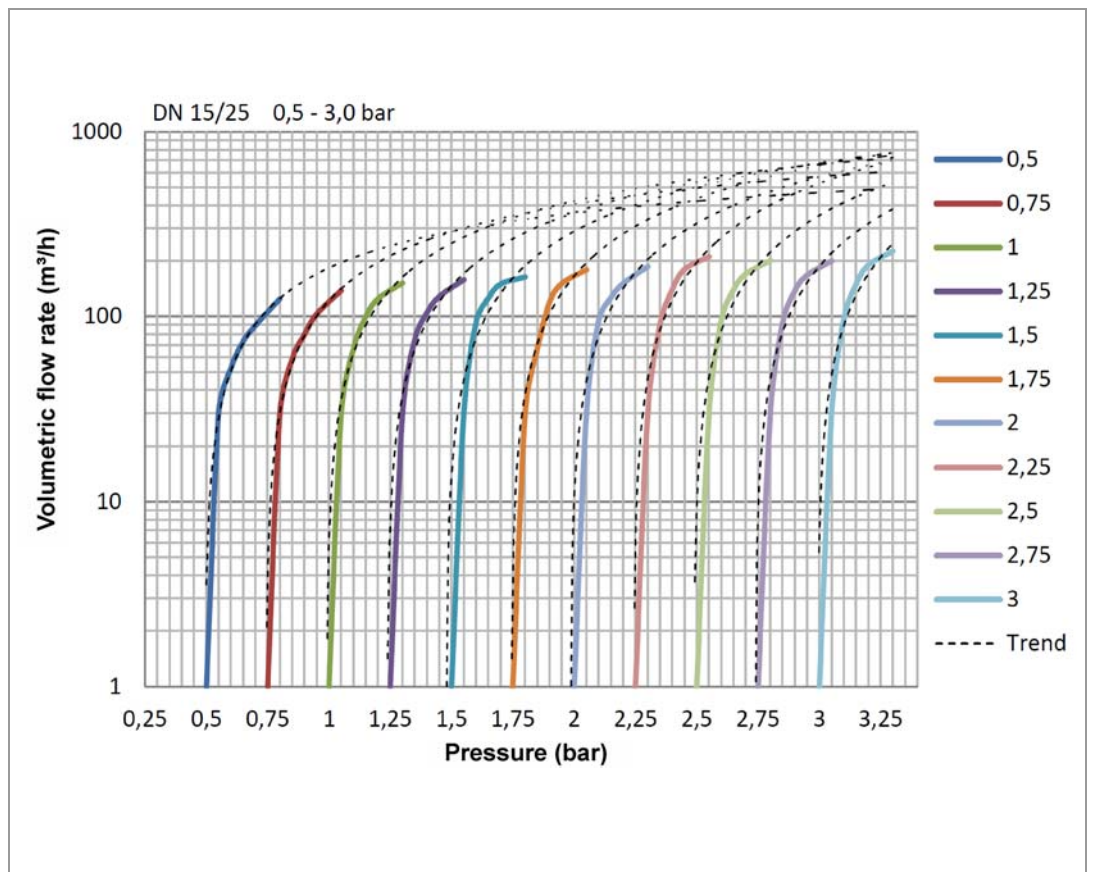

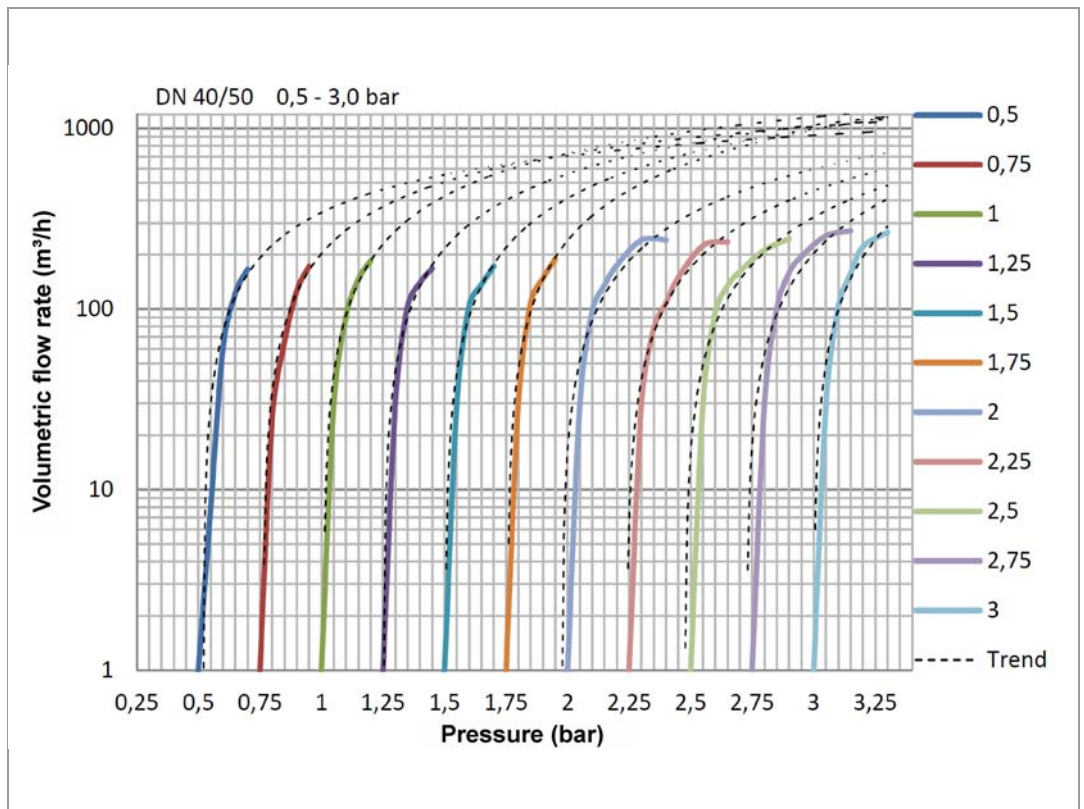
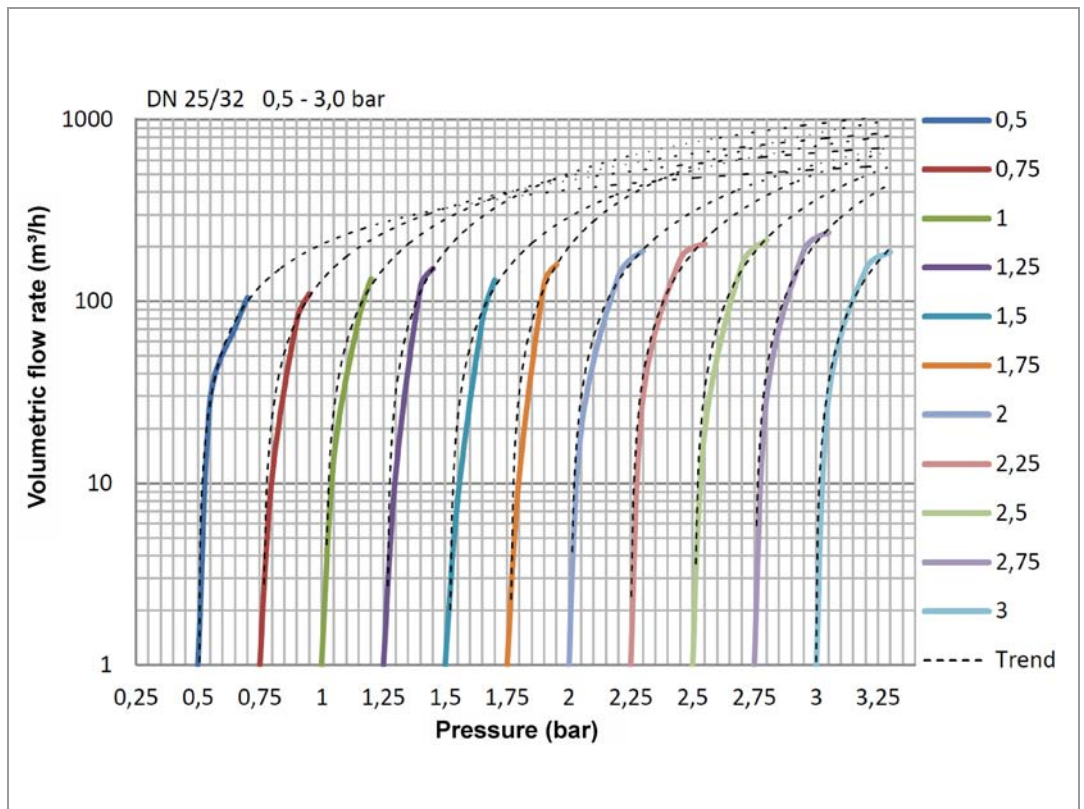

► Bunging valve DN15/25 | DN25/32 | DN40/50 Set pressure: 1,20 - 3,00 bar (air 20°C)

Set pressure (bar)	Reseating pressure (bar)			Volumetric flow rate (m³/h)											
				+ 0,1bar			+ 0,15bar			+ 0,2bar			+ 0,3bar		
1,20 - 3,00	DN 15/25	DN 25/32	DN 40/50	DN 15/25	DN 25/32	DN 40/50	DN 15/25	DN 25/32	DN 40/50	DN 15/25	DN 25/32	DN 40/50	DN 15/25	DN 25/32	DN 40/50
	1,2	1,13	1,16	1,14	52,49	10,05	x	125,80	96,84	92,31	131,23	141,18	152,04	165,62	x
1,4	1,33	1,36	1,35	67,875	10,22	x	113,13	59,46	14,94	139,37	132,85	74,72	193,67	x	189,86
1,6	1,53	1,52	1,52	60,635	12,39	41,63	120,37	66,71	110,41	142,09	127,70	167,43	177,38	x	235,30
1,8	1,70	1,72	1,72	85,975	19,06	x	132,13	59,09	51,59	140,28	129,61	86,88	152,95	x	203,63
2	1,93	1,95	1,92	x	x	x	x	x	52,74	61,54	162,58	95,81	181,00	210,88	194,26
2,2	2,10	2,15	2,10	x	x	x	90,50	x	17,00	114,03	170,94	32,52	135,75	208,10	198,81
2,4	2,90	2,33	2,28	x	x	x	65,93	x	x	144,16	140,28	67,68	177,56	203,63	157,34
2,6	2,48	2,53	2,48	99,801	x	x	121,98	x	x	126,24	141,18	111,32	142,45	230,78	196,39
2,8	2,69	2,74	2,71	x	x	x	129,42	x	x	132,13	126,70	109,00	195,48	226,25	167,01
3	2,89	2,96	2,90	x	x	x	45,25	x	x	113,13	230,78	172,86	200,91	253,40	235,30

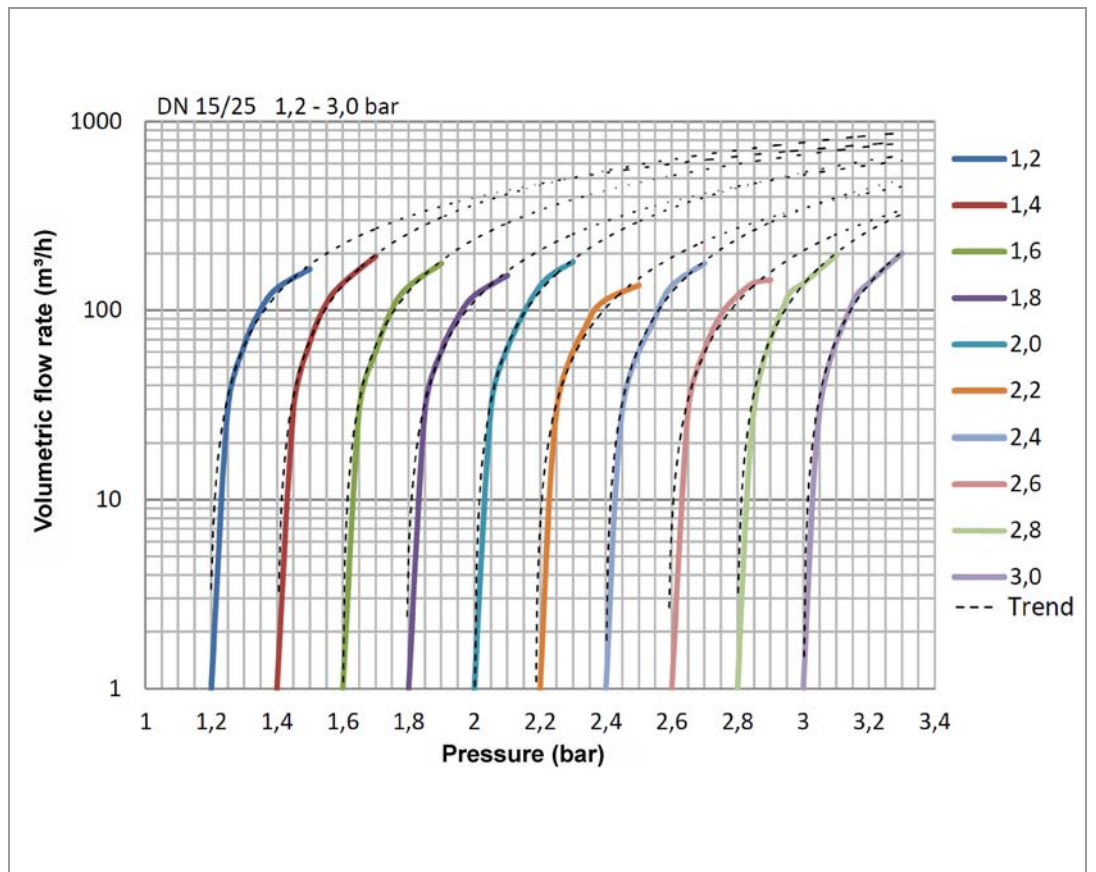

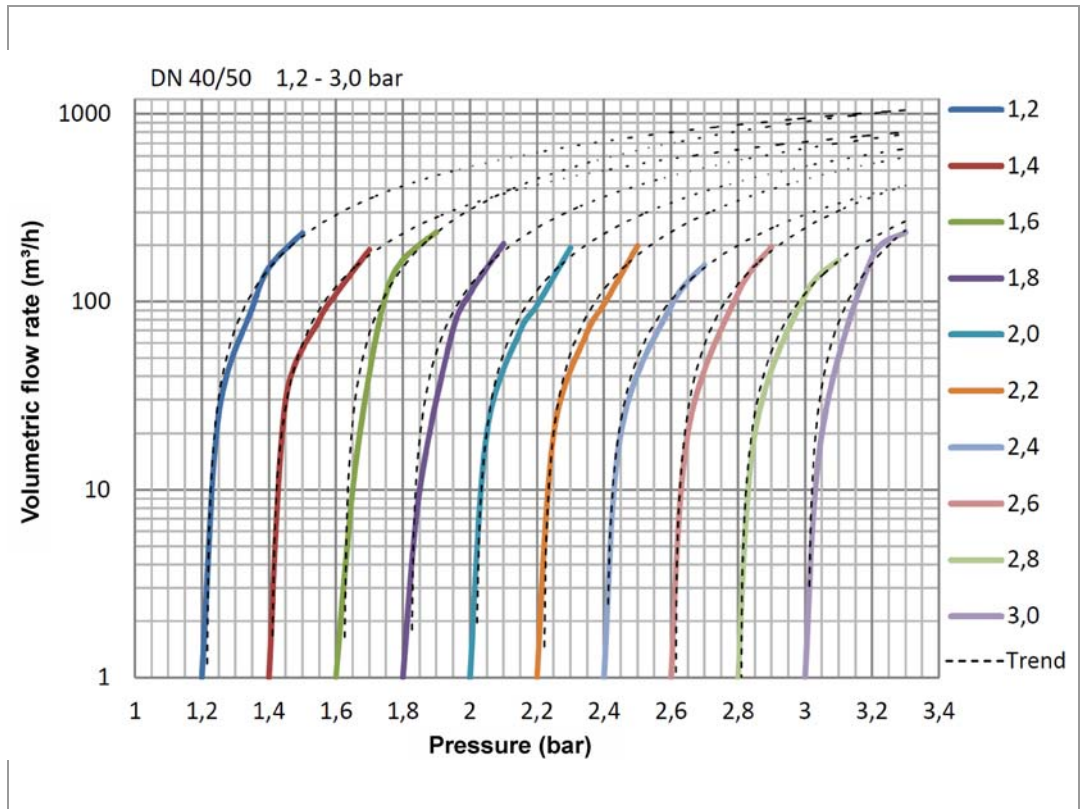
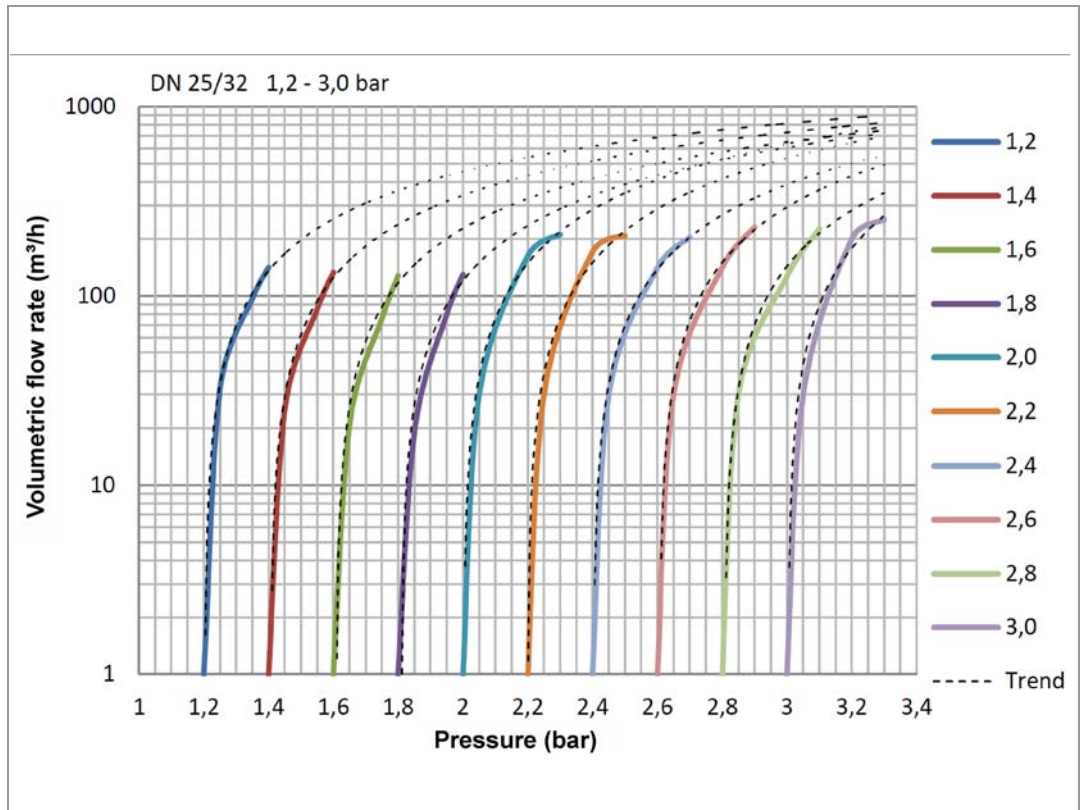

➤ Bunging valve DN15/25 | DN25/32 | DN40/50 Set pressure: 1,50 - 4,00 bar (air 20°C)

Set pressure (bar)	Reseating pressure (bar)			Volumetric flow rate (m³/h)											
				+ 0,1bar			+ 0,15bar			+ 0,2bar			+ 0,3bar		
1,50 - 4,00	DN 15/25	DN 25/32	DN 40/50	DN 15/25	DN 25/32	DN 40/50	DN 15/25	DN 25/32	DN 40/50	DN 15/25	DN 25/32	DN 40/50	DN 15/25	DN 25/32	DN 40/50
1,50	1,44	1,45	1,46	44,59	43,84	115,84	117,05	123,89	145,71	127,27	153,43	196,39	160,72	x	230,78
1,75	1,67	1,69	x	117,05	15,25	x	130,06	135,33	x	141,21	152,48	x	177,44	x	x
2,00	1,92	1,93	1,95	134,71	x	103,17	144,00	x	139,37	158,86	174,40	194,58	187,66	215,38	238,92
2,25	2,15	2,20	x	127,27	x	x	138,42	x	x	162,58	181,07	x	199,74	221,10	x
2,50	2,40	2,45	2,42	132,85	x	115,15	144,92	x	142,40	168,15	190,60	184,59	196,95	236,34	232,06
2,75	2,60	2,68	x	151,14	x	x	162,90	x	x	191,86	206,34	x	210,87	231,68	x
3,00	2,90	2,90	2,90	170,60	x	x	168,89	x	187,23	186,81	191,37	219,75	213,25	236,90	261,94
3,25	3,07	3,16	x	22,63	x	x	145,71	x	x	165,62	209,03	x	203,63	230,39	x
3,50	3,44	3,42	3,37	165,48	x	x	169,75	x	211,84	183,40	165,62	239,97	213,25	221,73	279,52
3,75	3,65	3,70	x	188,11	x	x	193,38	x	x	201,29	181,16	x	228,54	232,25	x
4,00	3,87	3,92	3,82	190,74	x	x	199,53	x	138,88	203,93	233,18	145,04	233,81	242,47	149,43

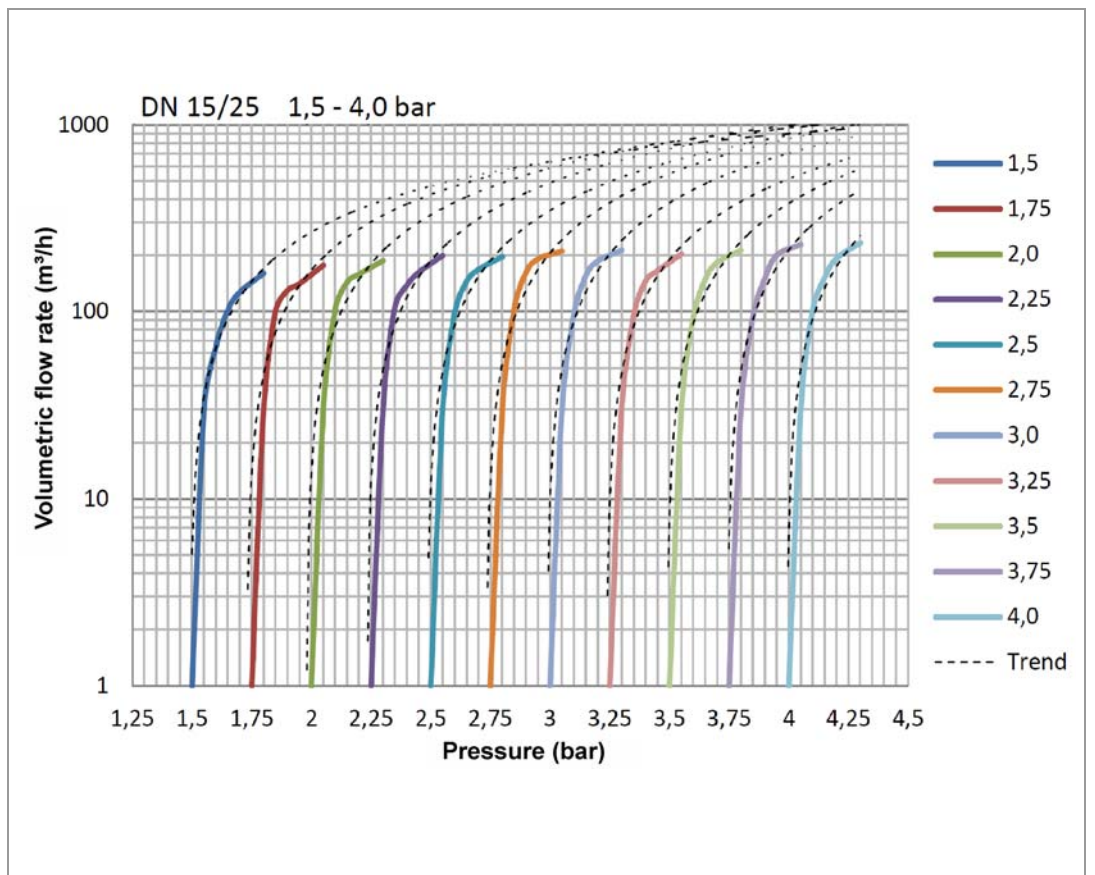



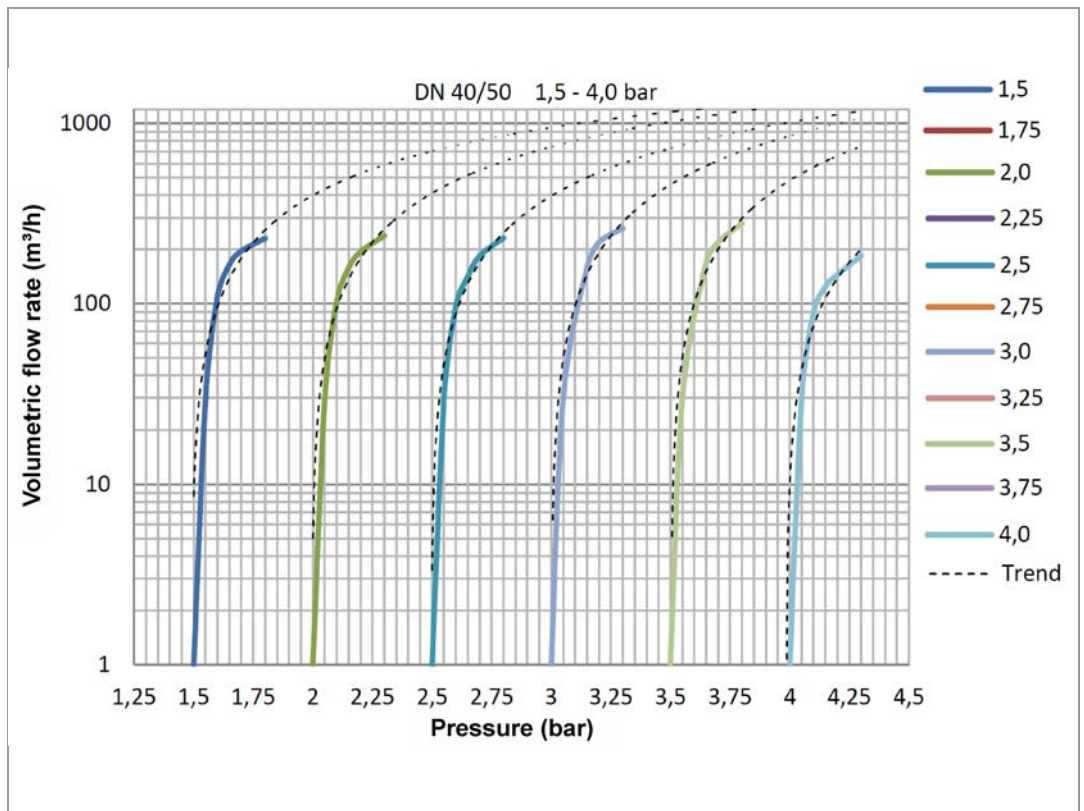
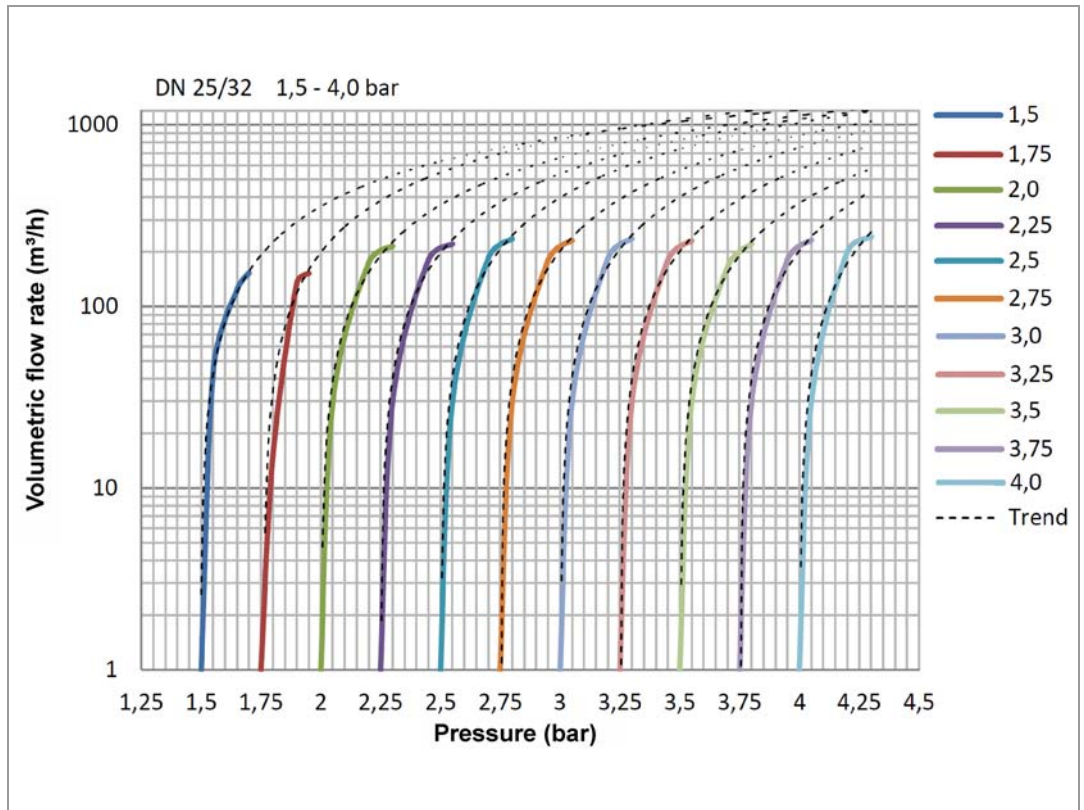



## **Declaration of incorporation**

Translation of the original

*Manufacturer /* authorised representative:

KIESELMANN GmbH  
Paul-Kieselmann-Str. 4-10  
75438 Knittlingen  
Germany

Authorised representative,  
for compiling technical documents:

Achim Kauselmann  
KIESELMANN GmbH  
Paul-Kieselmann-Str. 4-10  
75438 Knittlingen  
Germany

### **Produktbezeichnung**

pneum. Lift actuators  
pneum. Rotary actuators  
Ball valves  
Butterfly valves  
Single seat valves  
Flow control valves  
Throttle valve  
Overflow valve  
Double seat valve  
Bellow valves  
Sampling valves  
Two way valves  
Tankdome fitting  
Safety valve

### **Funktion**

Stroke movement  
Rotary movement  
Media cutoff  
Media cutoff  
Media cutoff  
Control of liquefied media  
Control of liquefied media  
Definition of fluid pressure  
Media separation  
Sampling of liquids  
Sampling of liquids  
Media cutoff  
Prevention of overpressure and vacuum, Tank cleaning  
Prevention of overpressure

The manufacturer hereby states that the above product is considered as an incomplete machine in the sense defined in the Directive 2006/42/EC on Machinery. The above product is exclusively intended to be installed into a machine or an incomplete machine. The said product does not yet conform to all the relevant requirements defined in the Directive on Machinery referred to above for this reason.

The specific technical documents listed in Appendix VII, Part B, have been prepared. The Authorized Agent empowered to compile technical documents may submit the relevant documents if such a request has been properly justified.

Commissioning of an incomplete machine must not only be carried out if it has been determined that the respective machine into which the incomplete machine is to be installed conforms to the regulations set out in the Directive on Machinery referred to above.

The above product conforms to the requirements of the directives and harmonized standards specified below:

- Directive 2014/68/EU
- DIN EN ISO 12100 Safety of machinery

Knittlingen, 10. 11. 2015

i.V. Uwe Heisswolf  
Head of Development